



RETIS
CONSTRUCTION

TYPICAL TOWER W2000F/H30

ASSEMBLY DRAWING

SCALE 1:150

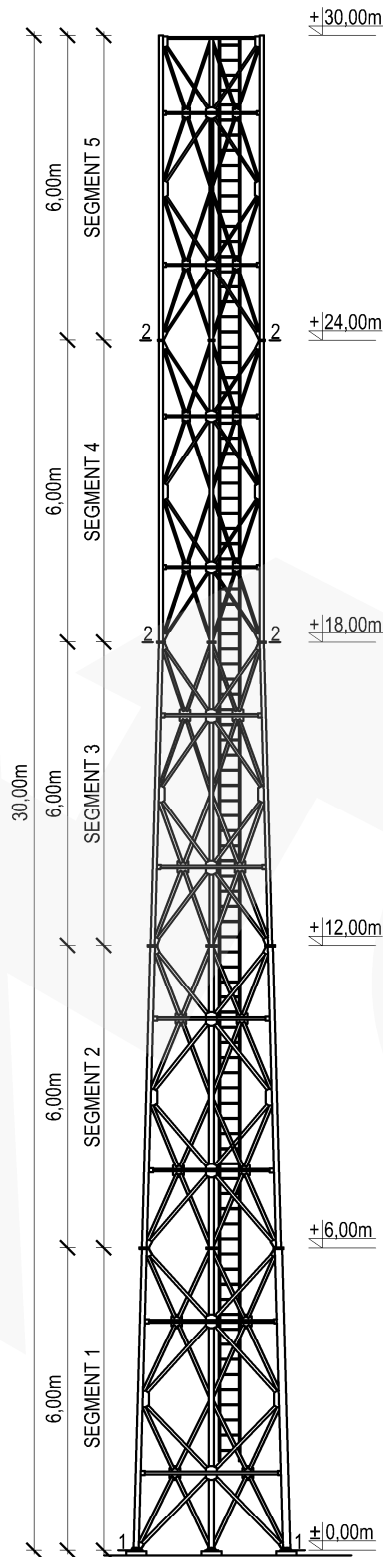

SECTION 1-1

SCALE 1:50

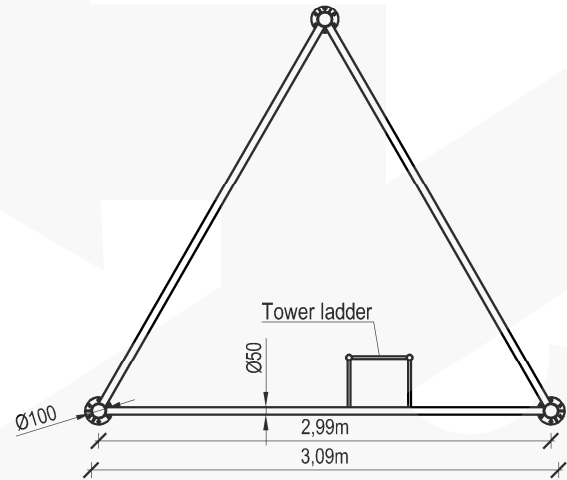

SECTION 2-2

SCALE 1:50

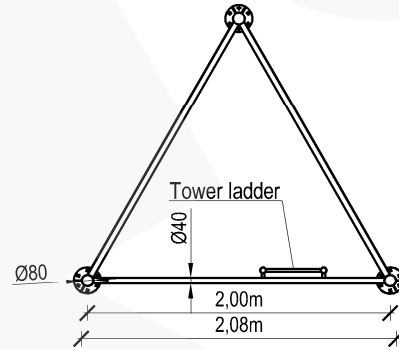

NOTES :

1. Typical tower construction W2000F/H30
2. Aluminum alloy: EN AW-6005A T6
3. Connections segments: flange connection
4. Angel plate linked with fillet weld
5. Characteristic wind speed: $V_k=22\text{m/s}$
6. Terrain category: II
7. Reliability class: II
8. Ice density: 700kg/m^3
9. Ice thickness: 2,0cm
10. Equipment total weight limit on the tower: 120kg
11. Equipment area on the tower:
- $S=1,70\text{m}^2$ at the top of the tower
12. Tower weight (with ladder): 488kg
13. Safety rail system: SKC BLOCK
14. Working platform: optional
15. Tower must be set under construction law
16. Construction on which tower will be located must be able to transfer reactions
17. Lead assembly with wind speed not more than 5m/s

Manufacturer: RETIS WWW.RETIS.PL WWW.MASZTY-RETIS.PL			
Investment: SERIES OF ALUMINUM LATTICE TOWERS - TYPE- 2000F			
Drawing title: TYPICAL TOWER W2000F/H30 - ASSEMBLY DRAWING + SECTIONS			
Date: 02.2013	Phase: typical project	Project No.: RETIS W2000F	Revision: ...
Industry: construction	Project No.: RETIS_KK_W2000F_H30		