



RETIS
CONSTRUCTION

TYPICAL TOWER W1000F/H15

ASSEMBLY DRAWING

SCALE 1:75

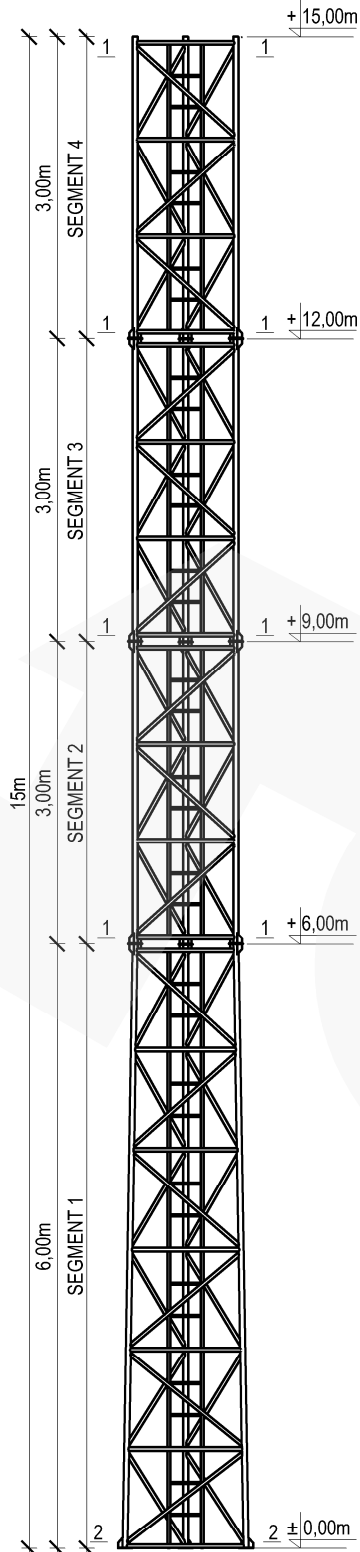

SECTION 1-1

SCALE 1:20

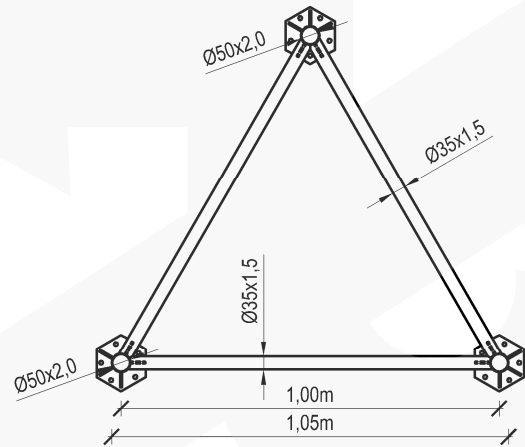

SECTION 2-2

SCALE 1:20

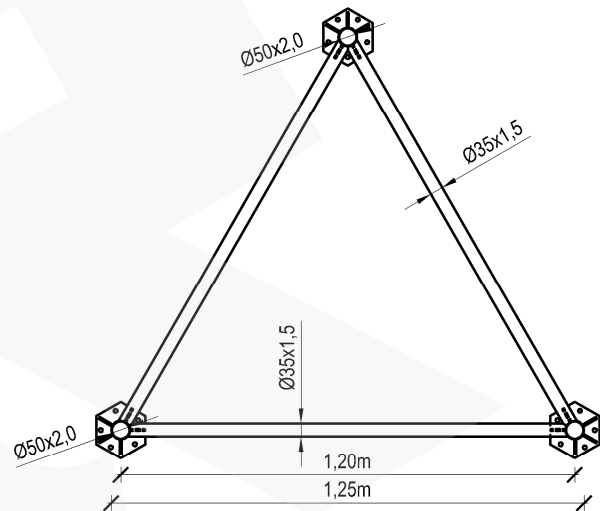

NOTES :

1. Typical tower construction M1000F/H18
2. Aluminum alloy: EN AW-6005A T6
3. Connections: fillet welded with TIG (GTAW) argon method by the requirements of ISO 3834-2
4. Characteristic wind speed: $V_k=22\text{m/s}$
5. Terrain category: II
6. Reliability class: II
7. Ice density: 700kg/m^3
8. Ice thickness: 2,0cm
9. Equipment total weight limit on the tower: 100kg
10. Equipment area on the tower:
- $S=1,2\text{m}^2$ at the top of the tower
11. Tower weight (with ladder): 101kg
12. Tower must be set under construction law
13. Construction on which tower will be located must be able to transfer reactions
14. Lead assembly with wind speed not more than 5m/s

Manufacturer: RETIS WWW.RETIS.PL WWW.MASZTY-RETIS.PL			
Investment: SERIES OF ALUMINUM LATTICE TOWERS - TYPE- 1000F			
Drawing title: TYPICAL TOWER W1000F/H15 - ASSEMBLY DRAWING + SECTIONS			
Date: 02.2013	Phase: typical project	Project No.: RETIS W1000F	Revision: ...
Industry: construction	Project No.: RETIS_KK_W1000F_H15		